

Digital Electronic Combination Lock

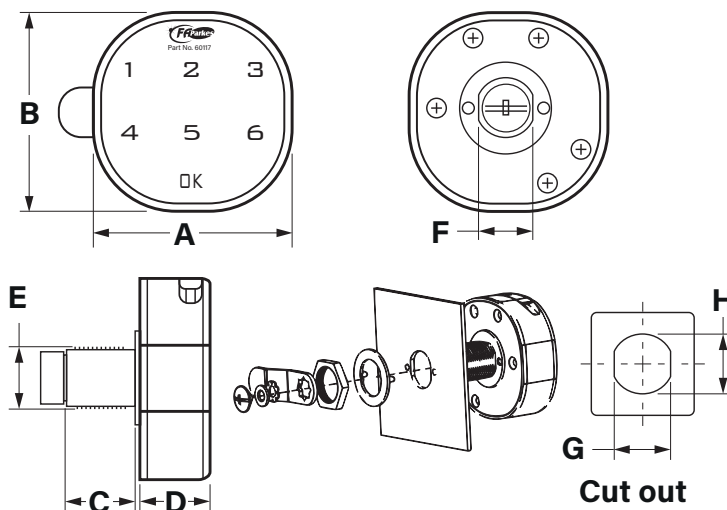

Digital Combination Lock in silver finish with black wipe clean touch pad.

Suitable applications include enclosures, lockers, metal and wooden office furniture, postal and medical furniture.

- Both user password and management password available
- Both private mode and public mode available
- 20mm or 30mm housing lengths available
- Touch pad design, super durable knob function
- Wipe clean touch pad

Part No.	A	B	C	D	E	F	G	H
60117	57.5	57.5	20	20	M18x1.25	16 ⁰ _{-0.05}	16.2	18
60129	57.5	57.5	30	20	M18x1.25	16 ⁰ _{-0.05}	16.2	18

All dimensions shown in mm unless otherwise stated. We reserve the right to alter specifications without notice.



Thousands of products available to buy online



Reliable international delivery service



The UK's leading stockist of locks, handles, hinges gas springs & accessories

Order online at
www.faparkes.co.uk

Your *One-Stop-Shop* for all your hardware requirements!



FA Parkes Ltd
Unit 4, Acorn Court
Butts Street,
Leigh
Lancashire, UK
WN7 3AE



+44 (0) 1942 681 996



+44 (0) 1942 681 997



www.faparkes.co.uk



sales@faparkes.co.uk

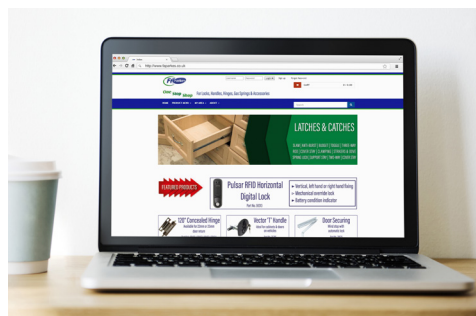

- Search by keyword or part number
- Browse by part type
- Product datasheet downloads
- No sign up required!



Digital Electronic Combination Lock

Part No. 60117

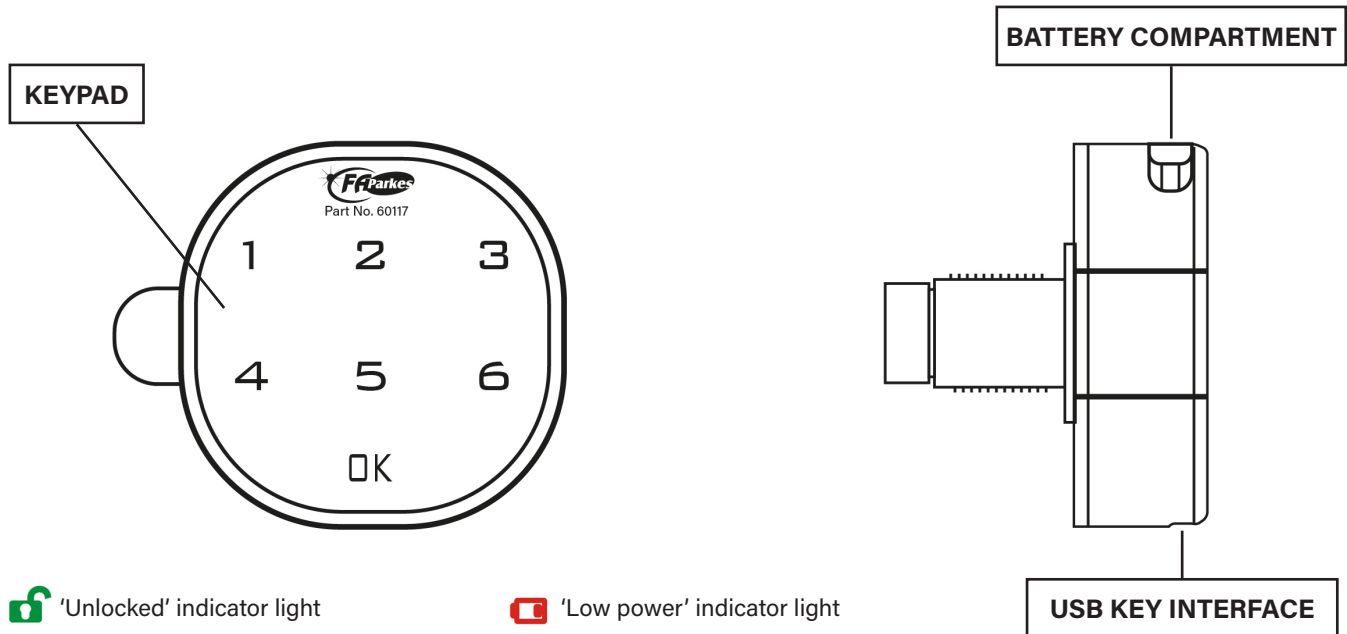



 'Unlocked' indicator light

 'Low power' indicator light

HOW TO OPERATE

Locking/Unlocking

To Unlock

1. Enter factory default passcode 1234 + **OK** or enter factory default Management Passcode 4321 + **OK**.
2. Long beep will sound.
3. Green indicator light  will come on
4. Rotate the knob 90° within 3 seconds to open the lock. If the wrong passcode is entered, a beep will sound 3 times.
5. If lock shows red light  this indicates low battery level.



NOTE: When entering Management Passcode to unlock, user passcode will be changed back to default 1234.

To Lock

1. Rotate the knob back to lock position.



SETTINGS

1. Change passcode

1. Enter current User Passcode + **OK**, or Management Passcode + **OK**. Long beep will sound and  will be displayed.
2. Press **OK** for at least 2 seconds, then  will flash.
3. Input new passcode, press **OK**. When you hear a long beep passcode has been changed.



NOTE: Passcode can consist of 4-15 digits. Management Passcode and User Passcode can not be the same code.

2. Turn on public mode, set temporary password

1. Enter current Management Passcode + **OK**, a long beep will sound and Unlocking indicator light  will be displayed
2. Press **OK** for at least 2 seconds, Unlocking indicator light  will flash. Press **OK** again.
3. Input "4 4" and press **OK**. When you hear a long beep public mode has been set.



3. Turn off public mode



1. Enter current Management Passcode + **OK**, a long beep will sound and Unlocking indicator light  will be displayed
2. Press **OK** for at least 2 seconds, Unlocking indicator light  will flash. Press **OK** again.
3. Input "4 3" and press **OK**. When you hear a long beep public mode has been set.

Set temporary password

1. Press **OK** . Unlocking indicator light  will flash.
2. Enter the new passcode consisting of between 4-15 digits.
3. Press **OK** to unlock and a long beep will sound to indicate temporary passcode has been set.

NOTE: If Unlocking indicator light  flashes once every 3 seconds indicates the passcode has already be taken. Temporary passcodes can only be used once.

4. Turn on/off Fake Pin code function



1. Enter current Management Passcode + **OK**, a long beep will sound and Unlocking indicator light  will be displayed.
2. Press **OK** for at least 2 seconds, Unlocking indicator light  will flash. Press **OK** again.
3. Enter "4 2" then press **OK**, If you hear a long beep sound, Fake Pin code mode has been turned on. Enter "4 1" then press **OK**, If you hear a long beep sound, Fake Pin code mode has been turned off.

Featuring **Anti-Theft Technology** and **Fake PIN** passcode function you can input any code(s) (maximum of 16 digits) before or after the real password to prevent the real password being seen.

FEATURES

1. If the passcode has been forgotten, you can get the decode number by providing the code on the lock body to the distributor to decode.
The passcode will be changed back to the original management passcode 4321 , user passcode 1234.
When the user passcode been forgotten, you can input the master passcode.
The user passcode will be changed back to the original user passcode.
2. Introduced with Anti-Theft Technology and Fake PIN passcode function; you can input any code(s) before or after the real passcode to prevent the real passcode being peeped. Maximum 16 digits
3. Auto-alarm will be activated when input wrong password 4 times and the lock will be died for 60 seconds.
4. Automatic power shortage prompts (When lock show this signal The lock cannot be operated when the voltage is very low
5. Equipped with 3V Cr2032 batteries, last password will not be lost after changing the battery.

TROUBLESHOOTING

Problem	Primary cause	Resolution
When entering the passcode, alarm beeps twice while   flashes once.	Power is too low.	Replace batteries.
When entering the passcode, alarm beeps while  is displayed and lock cannot be opened.	Knob is in incorrect position.	Turn knob to correct position.
Pressing keypad but no sound. Lock can be opened.	Buzzer is damaged/ broken.	Replace buzzer.

Order online at
www.faparkes.co.uk

Your *One-Stop-Shop* for all your hardware requirements!

