

Opening spring hinge 180mm long

new!

Spring force in N.m :
 M(0°) : 1,4 N.m / M(90°) : 0,9 N.m / M(180°) : 0,46 N.m

Stainless steel spring



A	B	C	D	F	G	S	note	part number	material	finish	weight
180	40	1.5	4				undrilled	71-1-3800	steel	zinc plated	124g
180	40	1.5	4	22.7	60	4	drilled	71-1-3806	steel	zinc plated	124g
180	40	1.5	4				undrilled	71-1-3788	stainless steel	raw	124g
180	40	1.5	4	22.7	60	4	drilled	71-1-3794	stainless steel	raw	124g

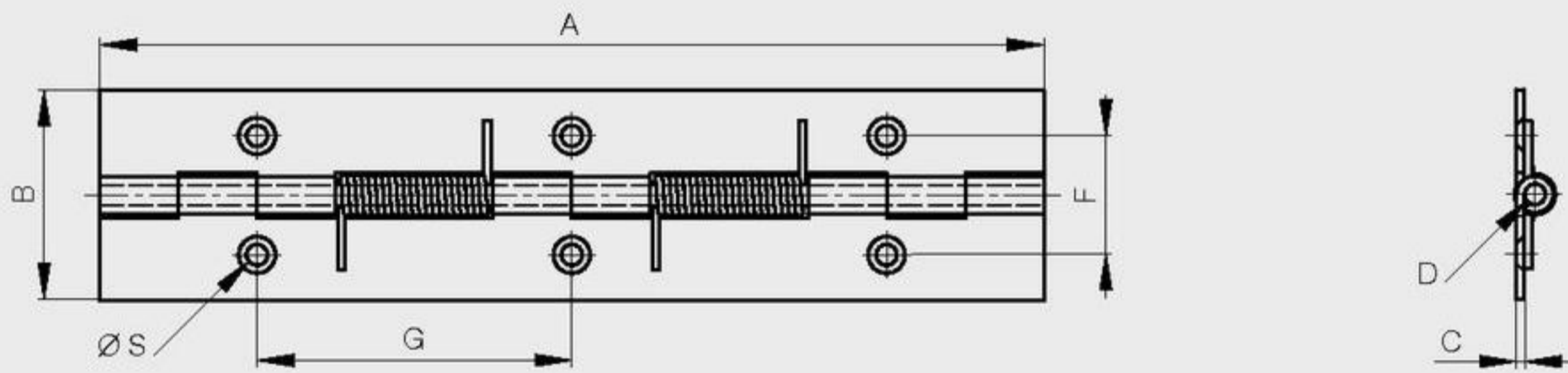

Closing spring hinge 180mm long

new!

Spring force in N.m :
 M(0°) : 0,46 N.m / M(90°) : 0,9 N.m / M(180°) : 1,4 N.m

Stainless steel spring

A	B	C	D	F	G	S	note	part number	material	finish	weight
180	40	1.5	4				undrilled	71-1-3803	steel	zinc plated	124g
180	40	1.5	4	22.7	60	4	drilled	71-1-3809	steel	zinc plated	124g
180	40	1.5	4				undrilled	71-1-3791	stainless steel	raw	124g
180	40	1.5	4	22.7	60	4	drilled	71-1-3797	stainless steel	raw	124g

